

# DPR-76BT

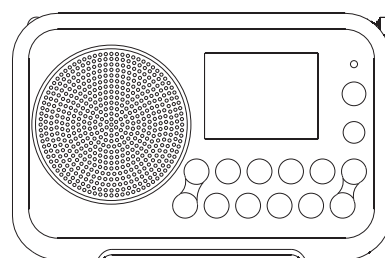

**GB**

Version 1

# Important safety instructions

- 1.** Read and understand all safety and operating instructions before the radio is operated.
- 2.** Retain instruction: The safety and operating instructions should be retained for further reference.
- 3.** Heed warnings. All warnings on the appliance and operating instructions should be followed.
- 4.** Follow all operations and use instructions.
- 5.** Water and moisture: The appliance should not be used near water. Do not use near a bathtub, washbowl, laundry tub, kitchen sink, wet basement, swimming pool, etc.
- 6.** Unplug the radio from the AC power outlet before cleaning. Use only a damp cloth for cleaning the exterior of the radio.
- 7.** Do not place the radio on an unstable cart, stand, bracket or table. The radio may fall, causing serious personal injury and damage to the radio.
- 8.** Ventilation: This radio should be situated so that its location or position does not interfere with its proper ventilation. For example, the radio should not be used on a bed, sofa, rug or other soft surfaces that may block the ventilation openings. It should not be placed in a built-in situation like a cabinet that may reduce air flow through the ventilation openings.
- 9.** Power sources: The radio should be operated only from the type of power source indicated on the marking label. If you are not sure of the type of power supply to your home, consult your radio dealer or power company.
- 10.** Mains adaptor: The mains adaptor should be positioned so it is not walked on, pinched, or items placed on top of it. Pay particular attention to wires at plugs, convenience receptacles, and the point where they exit from the unit. Unplug the mains adaptor by gripping the adaptor, not the wire. Operate the radio using only the current type of power source indicated. If you are not sure of the type of power supply to your home, consult your dealer or local power company.

11. Do not overload wall outlets or extension cords. This can result in a risk of fire or electrical shock. Never insert objects of any kind into the radio through opening. The objects may touch dangerous voltage points or short out parts. This could cause a fire or electrical shock.
12. If the radio is left unattended or unused for long periods of time, unplug it from the wall outlet. This will prevent damage caused by unplugging it from the wall outlet. This will prevent damage caused by lightning or power line surges.
13. If the radio is left unattended and used for a long period of time, remove the batteries. The batteries may leak and damage furniture or your radio.
14. Do not attempt to service the receiver yourself. Removing the cover may expose you to dangerous voltage, and will void the warranty. Refer all servicing to authorized service personnel.
15. Never push objects of any kind into this radio through opening as they may touch dangerous voltage points or short-out parts that could result in a fire or electric shock. Never spill liquid of any kind into the product.
16. The appliance should be serviced by qualified service personnel when:
  - The power supply cord or the plug has been damaged.
  - Objects have fallen or liquid has been spilled into the radio.
  - The radio has been exposed to rain or water.
  - The radio does not appear to operate normally or exhibits a marked change in performance.
  - The radio has been dropped, or the enclosure damaged.

17.  \_\_\_\_\_  
To prevent possible hearing damage, do not listen at high volume levels for long periods.

18.  **CAUTION** \_\_\_\_\_
  - minimum distances around the apparatus for sufficient ventilation;
  - the ventilation should not be impeded by covering the ventilation openings with items, such as newspaper, table-cloths, curtains, etc.;
  - no naked flame sources, such as lighted candles, should be placed on the apparatus;
  - attention should be drawn to the environmental aspects of battery disposal;
  - the use of apparatus in tropical and / or moderate climates.

19. A warning that batteries (battery pack or batteries installed) shall not be exposed to excessive heat such as sunshine, fire or the like.

# Important information on charging and using rechargeable batteries

- 1.** Recharge the batteries in any case at least every 2 months.
- 2.** Make sure the Battery Select switch inside the battery compartment is set to the “NiMH” position.
- 3.** Put the batteries in the compartment while paying attention to the correct polarity of the batteries (+ and -).
- 4.** First use: Charge new batteries in one continuous, uninterrupted, charge until they are full. This first charge may take longer than normal. For longer battery life it is advised to always recharge in one continuous, uninterrupted charge until batteries are full and to not recharge again while the batteries are still full.
- 5.** New batteries will only reach their full capacity after some time of use (several charge and discharge cycles).
- 6.** Leave the complete group of batteries in place inside the radio and do not use these batteries or a few of them for other purposes. This will result in a mix of (fully) charged and (partly) empty batteries. This can seriously damage the batteries and radio when recharged.
- 7.** It is advised to only charge batteries at room temperatures between 5 degrees C – 35 degrees C. In lower or higher temperatures full charge cannot be achieved.
- 8.** Depending on the capacity of the batteries, charging from “empty” to “full” can take several hours, even up to 6 hours or more.
- 9.** Do not charge batteries when the radio is hot or exposed to heat or heat sources.
- 10.** It is advised to clean the metal contacts of the batteries and of the charger inside the radio e.g. with a contact-spray from time to time.
- 11.** Do not use a mix of old and new rechargeable batteries.
- 12.** Do not use a mix of rechargeable and non-rechargeable batteries.
- 13.** Do not use a mix of full and empty rechargeable batteries.

14. Do not use batteries that have a different mAh capacity.
15. Do not use damaged, deformed or leaking batteries.
16. Battery level indication is an approximate indication only and can vary with battery type that is used.
17. Batteries can become hot during charging.
18. In cold conditions the capacity of batteries will be much lower than when used at normal room temperature.
19. Batteries (even when supplied with the radio), as being consumables, do not fall under the warranty conditions of the radio.
20. Batteries should not be disposed of by incineration and with household waste.
21. Disposable batteries should be taken to a suitable recycling center if possible.
22.  **CAUTION** —————  
“Risk of explosion if the battery is replaced by an incorrect type.”

# Controls

Front view

Left view

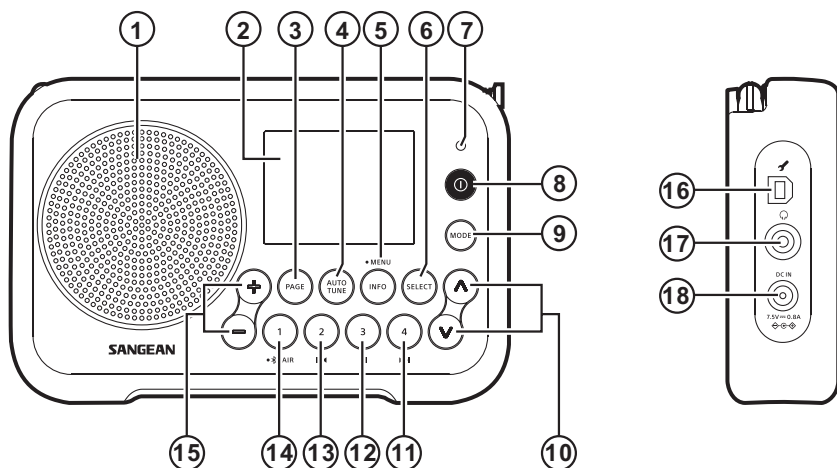

①	Speaker
②	LCD display
③	Page button
④	Auto Tune button
⑤	Info / Menu button
⑥	Select button
⑦	Charge / Battery Low indicator
⑧	On / Off button
⑨	Mode button

⑩	Tuning Up / Down button
⑪	Preset 4 / Next track / Fast-forward button
⑫	Preset 3 / Play / Pause button
⑬	Preset 2 / Previous track / Rewind button
⑭	Preset 1 / Bluetooth pairing button
⑮	Volume Up / Down button
⑯	USB socket for software upgrade
⑰	Headphone socket
⑱	DC IN socket

# Controls

## Back view

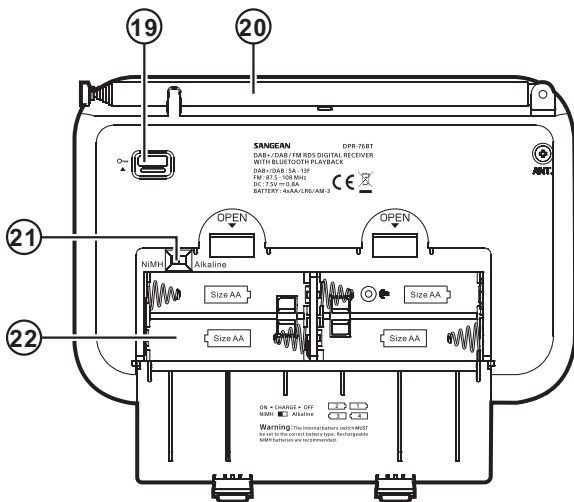

19	Lock switch
20	Telescopic aerial
21	NiMH / Alkaline batteries switch
22	Battery compartment

# Battery operation

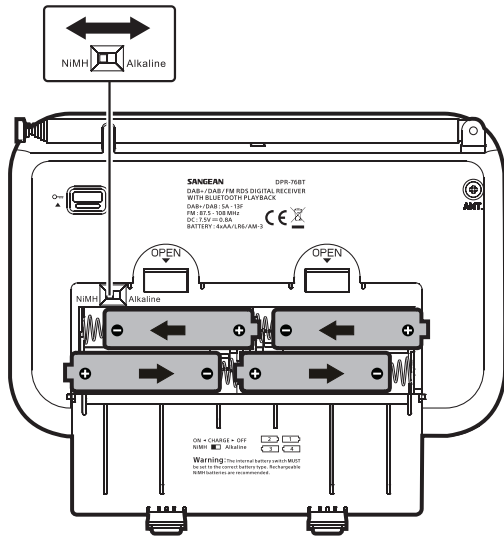

1. Open the battery cover on the rear of the unit by pushing the latch downward.

## NOTE

Before you insert the batteries, check the NiMH / Alkaline switch position. If you use non-rechargeable batteries, make sure the NiMH / Alkaline switch which located inside the battery compartment is switched to Alkaline position. If you use rechargeable batteries, make sure to switch NiMH / Alkaline switch to NiMH position.

2. Insert 4xLR6 (AA size) batteries into the space in the compartment. Ensure the batteries are inserted in accordance with the diagram shown. Close the battery compartment door.
3. The low battery indicator showing red, reduced power, distortion and a 'stuttering' sound are all signs that the batteries may need replacing.
4. If the radio is not to be used for any extended period of time it is recommended that the batteries are removed from the radio.



## **!** IMPORTANT

When using alkaline batteries the battery switch must be placed in the alkaline position. Failure to do so could result in serious damage to the batteries or radio.

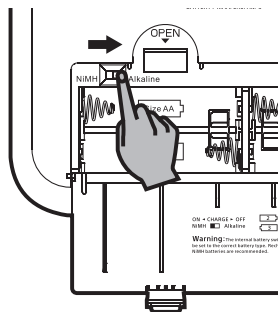

- If extended listening using batteries is anticipated, then the use of rechargeable batteries is recommended.

## Charging the batteries

## **!** IMPORTANT

When using rechargeable batteries the battery switch must be placed in the NiMH position. Batteries will only be charged when the radio is switched off and connected to the AC adaptor.

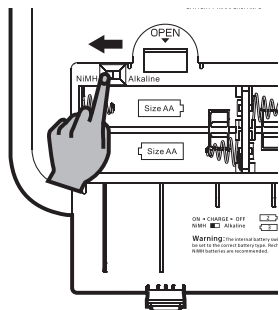

The charge indicator will flash green indicating that batteries are charging. Batteries will be fully charged in around 4-6 hours depending on their capacity. The charge indicator shows a steady green light when battery charging is complete. The display will show "Battery Full".

**i** Battery Full

During the charging process, if a battery is detected as faulty / damaged, the battery indicator will be shown with a cross under the corresponding battery number.



#### **⚠ NOTE**

- Duration for charging your batteries fully can vary according to the mAh capacity of the batteries. Higher mAh batteries require a longer charging time.
- When the batteries are exhausted, the battery light will show red for a short while. The radio will then switch itself off. It may not be possible to switch the radio back on until the batteries are recharged, or until the radio is connected to the mains adaptor.
- Under some conditions the charging LED indicator may switch off after flashing briefly. This may happen if the batteries are already freshly charged, or if the radio detects that you may be attempting to recharge alkaline batteries or mixed different types or capacity of rechargeable battery. In these cases the charging will be stopped.

## Using the AC power adaptor

The AC power adaptor required for this unit should be 7.5 volts DC at 0.8A center pin positive. Insert the adaptor plug into the DC socket on the left side of the radio. Plug the adaptor into a standard mains socket outlet.



Whenever the adaptor is used, the batteries are automatically disconnected. The AC adaptor should be disconnected from the main supply when not in use.

#### **⚠ IMPORTANT**

The mains adaptor is used as the means of connecting the radio to the mains supply. The mains socket used for the radio must remain accessible during normal use. In order to disconnect the radio from the mains completely, the mains adaptor should be removed from the mains socket outlet completely.

# Lock switch

The Lock switch is used to prevent unintentional operation of your radio.

1. Set the Lock switch located on the back of your radio to the 'Lock' position  . The power and all other buttons will be disabled, this will prevent accidental operation when your radio is packed in a suitcase or travel bag.
2. To release the lock, slide the Lock switch down to the 'Unlock' position  .

# Operating your radio – DAB

1. Carefully extend the telescopic aerial.
2. Press the On / Off button to switch on your radio. The display will show "Welcome to Digital Radio" for a few seconds.
3. If this is the first time the radio is used, a quick scan of the Band III DAB channels will be carried out. If the radio has been used before the last used station will be selected.
4. During the scanning process, as new stations are detected the station counter will increase and the stations will be added to the list which is stored in the radio. The bar graph indicates the progress of the scan.
5. When the scanning is completed the first station (in numeric-alpha order 0...9...A....Z) will be selected.
6. If the station list is still empty after the scan, your radio will show "No station found" for a moment.
7. If no signals are found it may be necessary to relocate your radio to a position giving better reception.

## Selecting a station – DAB

1. When playing a DAB radio station, the display normally shows the name of the current station with other related information.
2. Press the Tuning Up / Down button to scroll through the list of available stations.
3. Press and release the Select button to select the station. The display may show “Connecting...” while your radio finds the station.
4. Adjust the Volume up or Down buttons to the required setting.

### NOTE

If after selecting a station the station does not tune, it may be necessary to relocate your radio to a position giving better reception.

## Secondary services – DAB

Some DAB radio stations may have one or more secondary stations associated with them. If a station has a secondary station available then the secondary will appear in the list of station names beneath the main (or primary) station.

To listen to a secondary service, press the Tuning Up / Down button to scroll to the chosen station, and press the Select button to tune to the station. If the secondary service is not available (off-air) then the primary service will be selected.

# Display modes – DAB

Your radio has a range of display options when in DAB mode:

**1.** Press the Info button to cycle through the different options.

- |                               |  |
|-------------------------------|--|
| a. Text                       | Displays text messages such as the artist or track name, phone in number, traffic alerts, etc.   |
| b. Program Type               | Displays the type of station being listened to such as Pop, Classic, News etc.   |
| c. Multiplex Name / Frequency | Displays the name of the DAB multiplex to which the current station belongs as well as its broadcast frequency.  |
| d. Signal error / strength    | Displays the signal error and strength for the station being listened to. A lower error number indicates a better quality of radio signal. The signal strength graph can be used when positioning the radio or its antenna. For good reception the graph should occupy three or more blocks. |
| e. Bit rate and audio type    | Displays the digital bit rate and audio coding information for the station being listened to.  |
| f. Date                       | Displays the current date.   |
| g. DL Plus text               | Some stations may provide other programme related information for the display in addition to the regular text. If none is available, a message 'No info' is displayed.   |

A signal strength indicator is always shown in the lower area of the display on the right hand side. If the broadcast being received is in stereo, then the stereo speaker symbol will be shown. If the currently tuned station has been stored as a preset, then the preset number will also be shown.

If a DAB broadcast provides a slideshow image, this may be viewed by pressing the Select button. For full screen, press the Select button. Press the Select button again to exit the slideshow.

## Finding new stations – DAB

As time passes new stations may become available. To find new stations proceed as follows:

1. Press the On / Off button to switch on your radio.
2. Press the Mode button to select DAB radio mode.
3. Press the Auto Tune button to initiate the scan. You can also press and hold the Info / Menu button to enter the DAB menu. Then press the Tuning Up / Down button to select the "Scan". Press the Select button to initiate the scan. The display will show 'Scanning' and your radio will perform a scan of the DAB Band III frequencies. As new stations are found the station counter will increase and stations will be added to the list. The bar graph indicates the progress of the scan.

## Manual Tuning – DAB

Manual tuning allows you to tune directly to the various Band III DAB channels (5A to 13F).

1. When in DAB mode press and hold the Info / Menu button to enter the DAB menu.
2. Press the Tuning Up / Down button to select the "Manual tune".
3. Press the Select button to enter manual tune option.
4. Press the Tuning Up / Down button to choose the required DAB channel.
5. Press the Select button to cause the radio to tune to the chosen channel.

# Dynamic Range Control settings – DAB

Dynamic Range Control (also known as DRC) can make quieter sounds easier to hear when your radio is used in a noisy environment by reducing the dynamic range of the audio signal.

1. When in DAB mode press and hold the Info / Menu button to enter the DAB menu.
2. Press the Tuning Up / Down button to select the “DRC”.
3. Press the Select button to enter the DRC adjustment mode. The current DRC setting will be indicated with an asterisk.
4. Press the Tuning Up / Down button to highlight the required DRC setting (the default is Off).  
'High' - DRC is set as sent by broadcaster.  
'Low' - DRC level is set to 1 / 2 that sent by broadcaster.  
'Off' - DRC is switched off, Broadcast DRC will be ignored.
5. Press the Select button to confirm the setting.

## NOTE

Not all DAB broadcasts use the DRC function. If the broadcast does not provide DRC information, then the DRC setting in the radio will have no effect.

# Station order setup – DAB

Your radio has 3 station order settings from which you can choose. The station order settings are, alphanumeric, multiplex and active.

## NOTE

The default station order on your radio is alphanumeric.

1. When in DAB mode press and hold the Info / Menu button to enter the DAB menu.

2. Press the Tuning Up / Down button to select the “Station Order”.
3. Press the Select button to enter the station order adjustment mode.
4. Press the Tuning Up / Down button to choose 'Alphanumeric', 'Multiplex' and 'Active'.  
'Alphanumeric' - sorts the station list alpha-numerically 0...9 A...Z.  
'Multiplex' - organizes the station list by DAB multiplex.  
'Active' - shows only those stations for which a signal can be found.  
The current setting is indicated by an asterisk.
5. Press the Select button to confirm the required station order.

## Prune stations – DAB

If you move to a different part of the country, some of the stations which were listed may no longer be available. Also, from time to time, some DAB services may stop broadcasting, or may change location or frequency. Stations which cannot be found, or which have not been received for a very long time are shown in the station list with a question mark. The Prune stations function will delete the marked DAB stations from your station list.

1. When in DAB mode press and hold the Info / Menu button to enter the DAB menu.
2. Press the Tuning Up / Down button to select the “Prune Station”.
3. Press the Select button to enter adjustment mode.
4. Press the Tuning Up / Down button to select to “Yes” or “No”. To activate the Prune function select “Yes”, then press the Select button to confirm the setting. If you do not wish to prune stations, select “No” and then press the Select button to confirm the setting.

### NOTE

If you have moved your radio to a different part of the country you should also carry out a search for new stations (please see the section 'Finding new stations').



# Operating your radio – FM

- 1.** Carefully extend the telescopic aerial.
- 2.** Press the On / Off button to switch on your radio.
- 3.** Press the Mode button to select the FM band.
- 4.** To scan up in frequency, press and hold the Tuning Up button. (Alternatively, first press the Tuning Up button and then press the Auto Tune button.) Your radio will scan in an upwards direction (low frequency to high frequency) and stop automatically when it finds a station of sufficient strength.  
To scan down in frequency, press and hold the Tuning Down button. (Alternatively, first press the Tuning Down button and then press the Auto Tune button.) Your radio will scan in a downwards direction and stop automatically when it finds a station of sufficient strength.
- 5.** After a few seconds the display will update. The display will show the frequency of the signal found. If the signal is strong enough and there is RDS data present then the radio will display the station name.
- 6.** When the end of the waveband is reached your radio will recommence tuning from the opposite end of the waveband.
- 7.** Press the Volume Up / Down button to adjust the sound level as needed.
- 8.** To switch off your radio, press the On / Off button.

## Manual tuning – FM

1. Press the On / Off button to switch on your radio.
2. Press the Mode button to select the FM band.
3. Press either the Tuning Up or Down buttons to tune to a station. The frequency will change in steps of 50kHz.
4. When the end of the waveband is reached the radio will recommence tuning from the opposite end of the waveband.
5. Press the Volume Up / Down button to adjust the sound level as needed.

## Display modes – FM

Your radio has a range of display options when in FM mode:

1. Press the Info button to cycle through the different options.
  - a. Text Displays text messages such as the artist or track name, phone in number, traffic alerts, etc.
  - b. Program Type Displays the type of station being listened to such as Pop, Classic, News etc.
  - c. Frequency Displays the frequency of the FM signal.
  - d. Date Displays the current date.

### NOTE

These FM mode information displays are only available when the radio is able to receive RDS information from the broadcaster.

The RDS indicator at the bottom of the display shows that there is some RDS data present in the broadcast being received.

## Scan sensitivity setting – FM

Your radio will normally scan for FM broadcasts which are strong enough to give good reception. However, you may wish the Auto-scan function to also be able to find weaker signals, possibly from more distant radio transmitters. Your radio includes a local / distant option for the Auto-scan function.

1. When in FM mode, press and hold the Info / Menu button to enter the FM menu.
2. Press the Tuning Up / Down button to select "Scan zone". Press the Select button to enter the setting. The current scan setting is indicated with an asterisk.
3. Press Tuning Up / Down button to choose either the 'Local' or 'Distant' option. The Distant option will allow the radio to find weaker signals when scanning.
4. Press Select button to confirm the setting. The Local or Distant setting is stored in the radio and remains in force until changed or until a system reset.

## Stereo / Mono switching – FM

If the FM radio station being listened to has a weak signal, some hiss may be audible. It is possible to reduce this hiss by forcing the radio to play the station in mono rather than stereo.

**1** Ensure your radio is in FM mode and tune to the required FM station.

**2** Press the Select button to switch to mono or stereo. The display will show "Force mono" or "Auto Stereo". If the broadcast being received is in stereo, then the stereo speaker symbol will be shown in the lower area of the display.

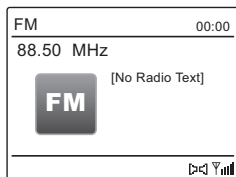
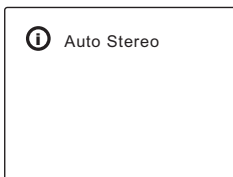
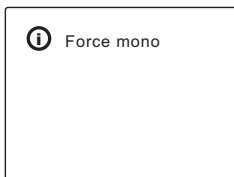

## Presetting stations in DAB and FM modes

There are 20 presets (5 pages x 4 presets) each for DAB and FM radio. They are used the same way for each operating mode.

1. Press the On / Off button to switch on your radio.
2. Tune to the required radio station as previously described.
3. To store the station as a preset, press the Page button to select the required preset page 1 to 5 and then press and hold the required preset button (1-4) until the display shows e.g. "Page2 M1 Saved".
4. Stations which are already stored in the presets may be overwritten by following the above procedure.

### NOTE

The radio station presets are retained in memory when the radio is switched off and disconnected from the mains supply.

## Recalling a preset in DAB and FM modes

1. Press the On / Off button to switch on your radio.
2. Select the required operating mode using the Mode button.
3. Press the Page button to select the required preset page and momentarily press the required Preset button, your radio will tune to the station stored in the selected preset memory. The chosen preset number is also shown in the lower area of the radio display, e.g. '★P2M1'.

# Listening music via Bluetooth streaming

You need to pair your Bluetooth device with your radio before you can auto-link to play stream Bluetooth music through your radio. Pairing creates a "bond" so two devices can recognize each other.

## Pairing and playing your Bluetooth device for the first time

1. With your radio switched on, press the Mode button to select Bluetooth function. The display will appear "Disconnected" to show the radio is discoverable.
2. Activate Bluetooth on your device according to the device's user manual to link to the radio. Locate the Bluetooth device list and select the device named "DPR-76BT" (With some Smartphone's that are equipped with earlier versions than BT 2.1 Bluetooth device, you may need to input the pass code "0000").
3. Once connected, there will be a confirmation tone sound and the name of your connected Bluetooth device will show on the display. You can simply select and play any music from your source device. The volume control can be adjusted from your source device, or directly from the radio.
4. Use the controls on your Bluetooth-enabled device or on the radio to play / pause and navigate tracks.

### NOTE

1. If 2 Bluetooth devices are pairing for the first time, both must search for your radio, it will show its availability on both devices. However, if one device links with this unit first, then the other Bluetooth device won't find it on the list.
2. If you take your source device out of range, the connection will be temporarily disconnected to your radio. Your radio will automatically reconnect if the source device is brought back in range. Be aware that during the period of disconnection, no other Bluetooth device can pair or link with your radio.
3. If "DPR-76BT" shows in your Bluetooth device list but your device cannot connect with it, please delete the item from your list and pair the device with the radio again following the steps described previously.
4. The effective operation range between the system and the paired device is approximately 10 meters (30 feet). Any obstacle between the system and the device can reduce the operational range.
5. Bluetooth connectivity performance may vary depending on the connected Bluetooth devices. Please refer to the Bluetooth capabilities of your device before connecting to your radio. All features may not be supported on some paired Bluetooth devices.
6. With some mobile phones, making/receiving calls, text messages, e-mails or any other activities unrelated to audio streaming may mute the Bluetooth audio streaming or even temporarily disconnect from your device. Such behavior is a function of the connected device and does not indicate a fault with your radio.

## Display modes - Bluetooth

Your radio has a range of display options when in Bluetooth mode. Note that the availability of information depends on the specific media format.

Press and release the Info button to cycle through the different options. If your connected device is able to provide information from the track being played, your radio can display the following in Bluetooth mode: Track name, Artist, Album and Date.

## Playing audio files in Bluetooth mode

When you have successfully connected your radio with the chosen Bluetooth source device you can start to play your music using the controls on your connected Bluetooth device.

1. Once playing has started adjust the volume to the required setting using the Volume control on your radio or on your enabled Bluetooth source device.
2. Use the controls on your Bluetooth source device to play / pause and navigate tracks. Alternatively, control the playback using Play / Pause, Next track, Previous track buttons on your radio.
3. Press and hold the Fast-forward / Rewind button to move through the current track. Release the button when the desired point is reached.

### NOTE

Not all player applications or devices may respond to all of these controls.

## Playing a previously-paired Bluetooth source device

The radio can memorize up to 6 sets of paired Bluetooth source devices, when the memory exceed this amount, the earliest pairing device will be over written from the device.

If your Bluetooth source device already paired with the radio previously, the unit will memorize your Bluetooth source device and it attempts to reconnect with a Bluetooth source device in memory which is last connected.

## Disconnecting your Bluetooth device

Press and hold the Bluetooth pairing button for 2-3 seconds to disconnect with your Bluetooth device. You can also press the Mode button to select any mode other than Bluetooth mode or turn off Bluetooth on your Bluetooth source device to disable the connection.

If you disconnect the Bluetooth device when you are in Bluetooth mode, the "Disconnected" will show on the display, indicating Bluetooth is available again for pairing.

### NOTE

When Bluetooth is not connected, the radio will automatically turn off after 15 minutes.

## Automatically updating the clock

You may specify that the radio sets its clock from DAB or FM radio broadcasts. After a power failure the radio will then set its clock the next time that you turn on the radio in DAB or FM mode.

Alternatively you may specify that the time is not automatically updated. In this case the clock must always be set manually after a power interruption.

1. With your radio switched on, press and hold Info / Menu button to access the menu for the current mode.
2. Press the Tuning Up / Down button to select "System settings". Press the Select button to enter the system settings menu. (Using the Tuning Up / Down and Select buttons to select "Back" will go back to a higher level menu.)
3. Press the Tuning Up / Down button to select "Time setup". Press the Select button to enter the setting.
4. Press the Tuning Up / Down button to select "Auto update". Press the Select button to enter the auto-update menu.
5. Press the Tuning Up / Down button to choose an update option from "From DAB", "From FM", or "No update" as required. Press the Select button to confirm your choice. The radio will then exit to the previous menu display.

## Setting the clock format

1. With your radio switched on, press and hold Info / Menu button to access the menu for the current mode.
2. Press the Tuning Up / Down button to select "System settings". Press the Select button to enter the system settings menu.
3. Press the Tuning Up / Down button to select "Time setup". Press the Select button to enter the setting.
4. Press the Tuning Up / Down button to select "Clock format". Press the Select button to enter the clock format setting. The current clock display format is marked with an asterisk.
5. Press the Tuning Up / Down button to select either 12 or 24 hour format. Press the Select button to confirm your choice of clock format. If the 12 hour clock format is chosen, the radio will display a 12 hour clock with an AM or PM indicator.

# Manually setting the clock

1. With your radio switched on, press and hold Info / Menu button to access the menu for the current mode.
  2. Press the Tuning Up / Down button to select "System settings". Press the Select button to enter the system settings menu.
  3. Press the Tuning Up / Down button to select "Time setup". Press the Select button to enter the setting.
  4. Press the Tuning Up / Down button to select "Set time". Press the Select button to enter the clock setup. The day digits will flash.
  5. Press the Tuning Up / Down button until the correct day is shown on the display. Press the Select button to confirm the setting. The month digits will then flash.
  6. Press the Tuning Up / Down button to select the correct month. Press the Select button. The year digits will then flash.
  7. Press the Tuning Up / Down button to select the correct year. Press the Select button. The hour digits will then flash.
  8. Press the Tuning Up / Down button to select the correct hour. Press the Select button. The minute digits will then flash.
  9. Press the Tuning Up / Down button to select the correct minutes. Then Press the Select button to confirm the setting.
- If the radio has been set to use a 12 hour format, there will be an option here for setting AM or PM for the clock time. Press the Tuning Up / Down button to select AM or PM. Press the Select button to confirm the setting.



# Brightness control

The brightness of the display can be adjusted when the radio is in use.

1. With your radio switched on, press and hold Info / Menu button to access the menu for the current mode.
2. Press the Tuning Up / Down button to select "System settings". Press the Select button to enter the system settings menu.
3. Press the Tuning Up / Down button to select "Backlight". Press the Select button to enter the setting menu
4. In Backlight menu, there are 2 settings:  
**Timeout:** to adjust the length of time before the backlight turns off.  
**On Level:** to adjust the brightness when the radio is in use.  
Press the Tuning Up / Down button to select your option and press the Select button to confirm your setting.

# Language selection

By default your radio will display all menus and messages in English. You can choose your preferred language.

1. With your radio switched on, press and hold Info / Menu button to access the menu for the current mode.
2. Press the Tuning Up / Down button to select "System settings". Press the Select button to enter the system settings menu.
3. Press the Tuning Up / Down button to select "Language". Press the Select button to enter the setting menu.
4. Press the Tuning Up / Down button until your preferred language is highlighted and press the Select button to confirm the setting.

# Headphone socket

A 3.5mm Headphone Socket located on the left hand side of your radio is provided for use with headphones. Inserting a plug automatically mutes the internal loudspeaker.

Please be aware that the sensitivity of headphones can vary widely. We therefore recommend setting volume to a low level before connecting headphones to the radio. It is also recommended to reduce the volume before unplugging your headphones.



## IMPORTANT

Excessive sound pressure from earphones and headphones can cause hearing loss. To prevent possible hearing damage, do not listen at high volume levels for long periods.

# Factory reset

If you wish to completely reset your radio to its initial state this may be performed by following this procedure. By performing a factory reset, all user entered settings will be erased.

1. With your radio switched on, press and hold Info / Menu button to access the menu for the current mode.
2. Press the Tuning Up / Down button to select "System settings". Press the Select button to enter the system settings menu.
3. Press the Tuning Up / Down button to select "Factory reset". Press the Select button to enter the setting.
4. Press the Tuning Up / Down button to select "Yes" or "No". If you do not wish to carry out a system reset, select "No" and then press the Select button to confirm the setting.
5. With "Yes" selected, press the Select button. A full reset will be performed. All presets and station lists will be erased. All settings will be set to their default values. After a system reset, the radio will be restarted. The display will show "Welcome to Digital Radio" and a scan of the DAB band III will be performed. In case of malfunction due to electrostatic discharge, reset the product (reconnection of power source may be required) to resume normal operation.

## Software version display

The software version display is provided for reference and customer support purposes and cannot be changed.

1. With your radio switched on, press and hold Info / Menu button to access the menu for the current mode.
2. Press the Tuning Up / Down button to select "System settings". Press the Select button to enter the system settings menu.
3. Press the Tuning Up / Down button to select "SW version". Press the Select button to display the software version.
4. Press the Info / Menu button to exit the software version display.

## USB socket for software upgrade

From time to time, new software features for your radio may be developed. Your radio has therefore been designed to allow its internal software to be updated using your USB upgrade port.

You should not attempt to update your radio unless it is recommended to you by Sangean Customer Services. Updating the software may remove all radio station presets and settings from your radio.

Software updates for your radio may be available in the future. As software updates become available software and information on how to update your radio can be found at: <http://www.sangean.com>

For more information, please contact our Head Office by sending an email to [contact@sangean.com](mailto:contact@sangean.com)

1. Using the micro USB cable (not supplied) to connect the USB socket on the left hand side of the radio and your PC USB port.
2. Go to the website above to download the latest software. Follow the on-screen instructions on your PC provided with the upgrade software to complete the software upgrade.

# Specifications

Power Requirements	
Mains Power Supply	INPUT: AC 100-240 V ~ 50/60 Hz
	OUTPUT: DC 7.5V 0.8A 6.0W
Batteries	4 x LR6 (AA size) Alkaline or NiMH rechargeable (not included)
Frequency Coverage	FM 87.5-108 MHz
	DAB 174.928-239.200 MHz
Bluetooth	
Bluetooth specification	Bluetooth® 5.0+EDR
Profile Support	A2DP, AVRCP
Bluetooth Audio CODEC	SBC, AAC
Transmitting Power	Power Class 2
Line of sight range	10 meters / 30 feet
The frequency and maximum transmitted power	2402MHz ~ 2480MHz: 1.73dBm (Bluetooth EDR)
Speaker	8Ω 2W
Output power	0.5W
Headphone socket	3.5mm diameter, stereo
Aerial System	DAB Telescopic aerial
	FM Telescopic aerial
Operating temperature range	0°C to + 35°C

The company reserves the right to amend the specifications without notice.



If at any time in the future you should need to dispose of this product please note that: Waste electrical products should not be disposed of with household waste. Please recycle where facilities exist. Check with your Local Authority or retailer for recycling advice. (Waste Electrical and Electronic Equipment Directive)

❖ The barcode label on the product is defined as below:

